

# What is Gloss?

Gloss

Haze

Distinctness of Image (DOI)

Reflected Image Quality (RIQ)

RSpec

[www.micomlab.com](http://www.micomlab.com)

 **MICOM INC.**  
LABORATOIRES · LABORATORIES

# Basics of Light Reflection

3 categories of reflections: Specular / Scattered / Diffuse

1

## 3 categories of reflections

1

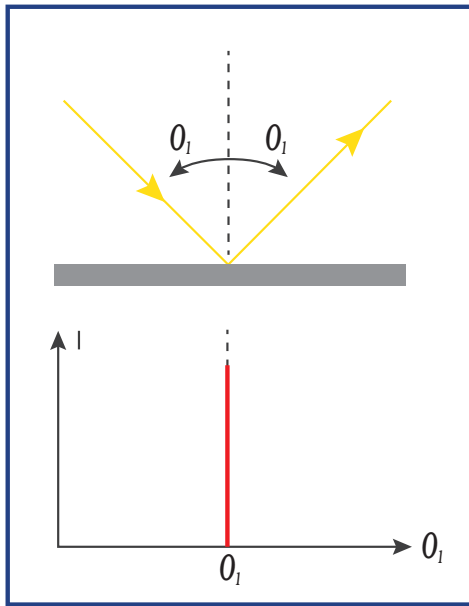

### Specular reflection

Mirrors, perfectly polished metals

Incoming and outgoing beams have the exact same angle.

2

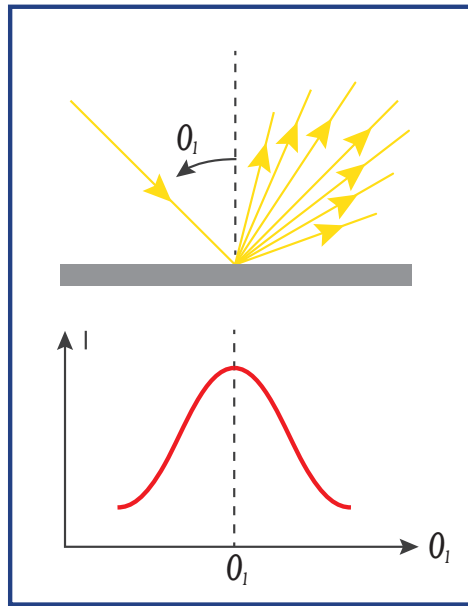

### Scattered reflection

Most materials fall into that category

Even if most of the light is reflected in the specular angle, surface defects will scatter the light creating a bell curve deflection. The bell curve shape will depend on the microtopography of the surface.

3

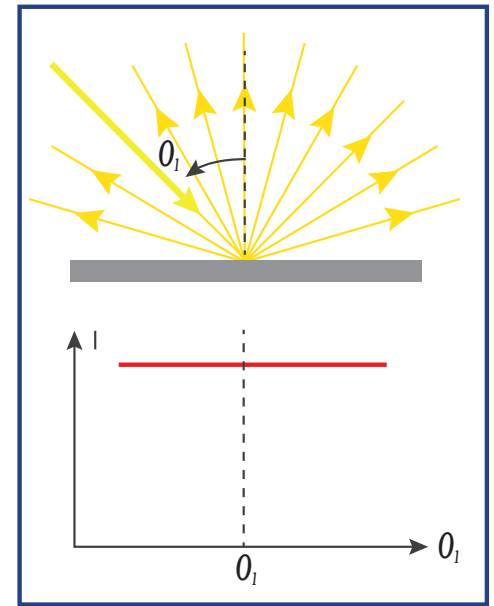

### Diffuse reflection

Best example; White paper. Also called Lambertian reflection.

Extreme case of scattered reflection where light is reflected in all directions with an isotropic distribution.

First Glossmeter (Glarimeter): 1914  
Well known and widely used



Glossmeters measure the 'shininess', brightness (quantity of the light directly reflected from the surface)

High gloss makes products visually appealing (Automotive, electronics, high end products)



Most used angles:

20° (70+ GU)  
60° (10-70 GU) / 85° (<10 GU)

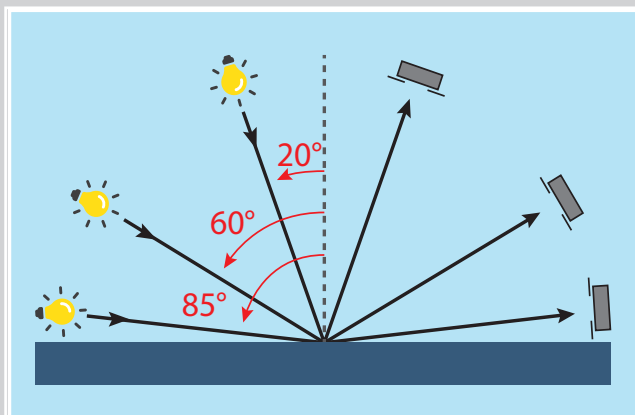

LIMITATIONS

Not sensitive to effects which reduce appearance quality

Unable to mimic the human eye perception of the surface! The human eye evaluates much more than the shininess of the surface...

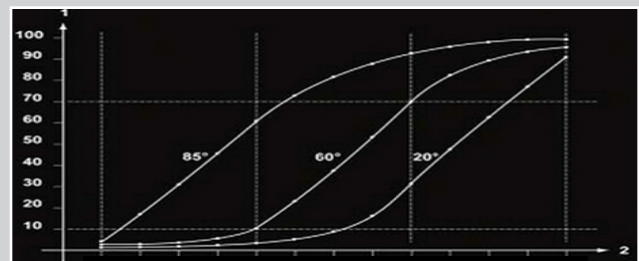

# What's New?

2 products with similar gloss can look very different... why?

Gloss is definitively part of the answer. However, 2 products with similar gloss can look very different...why?

**Distribution effect is the key**

In a glossmeter, the entering light is treated as one single value, the distribution effect (variation) is not taken into account (like it would be in the human eye). Beam is treated as a specular reflection.

Nowadays, equipment with light sensor arrays allow us to take measurements that mimic the light reflection on the human eyes cones.

## Three Basic Forms of Reflection

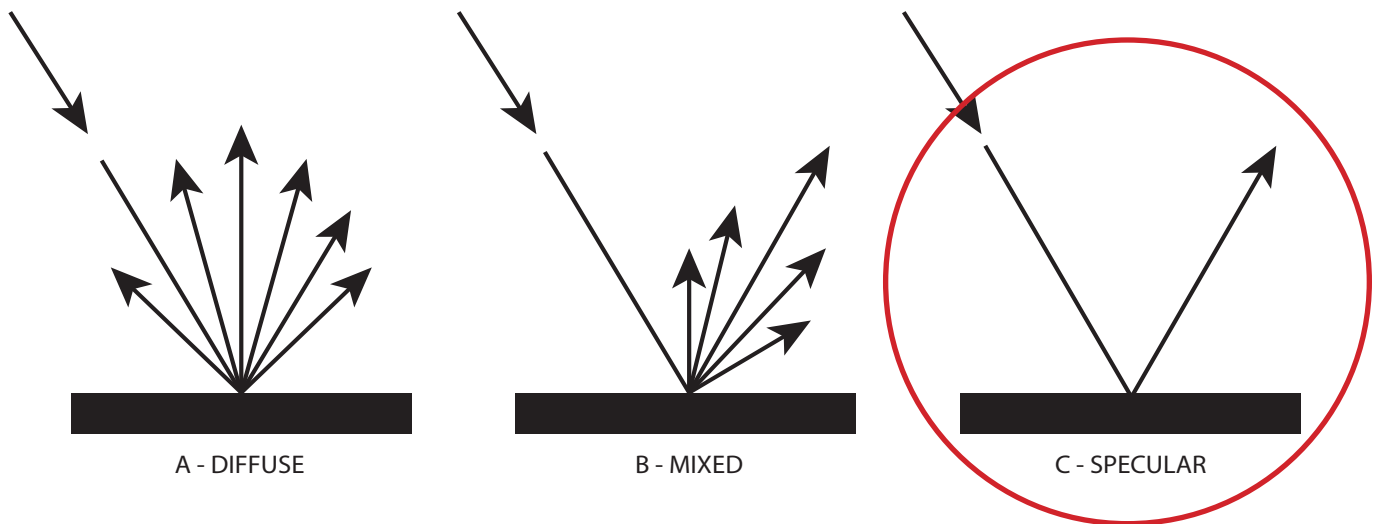

### Human eye

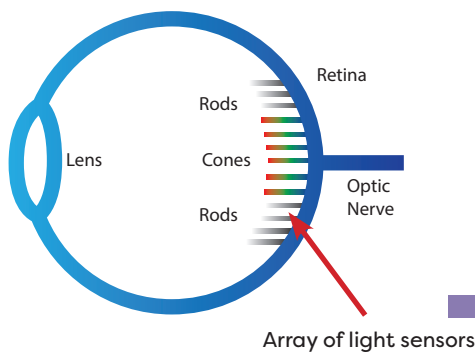

### Incorrect reading

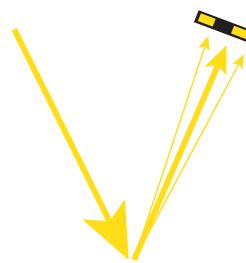

### Correct reading

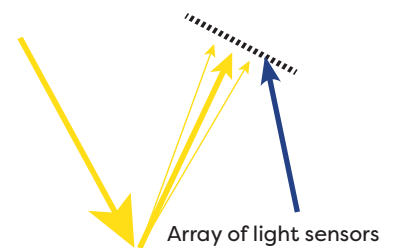

# What's New?

What are the parameters this new technology allows us to quantify?

## Haze

**DOI** (Distinctness Of Image)

**RIQ** (Reflected Image Quality)

**RSpec** (Smoothness quantification)

Even more accurate **Gloss** values!

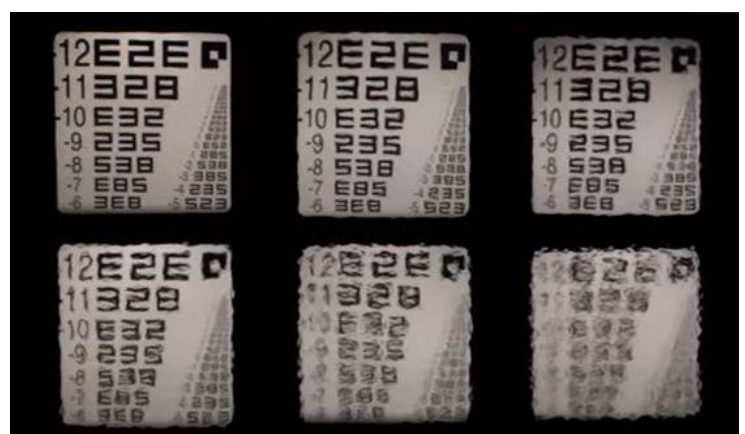
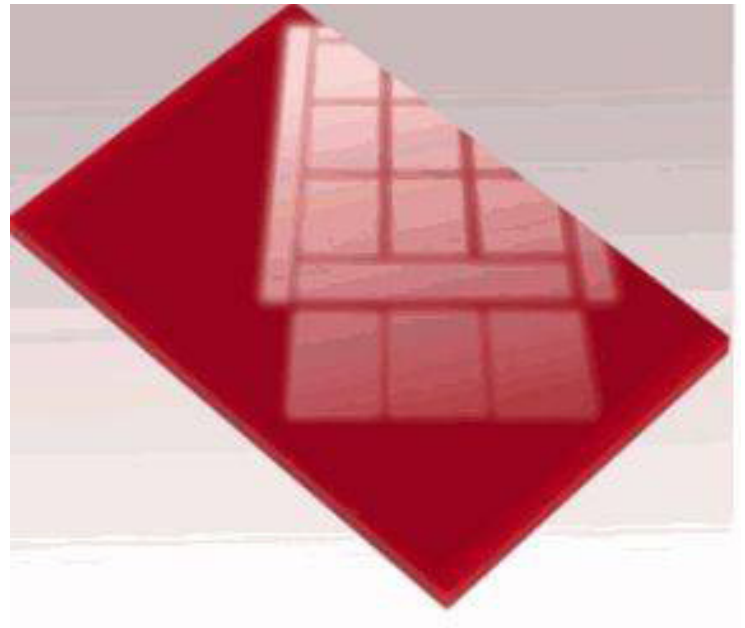
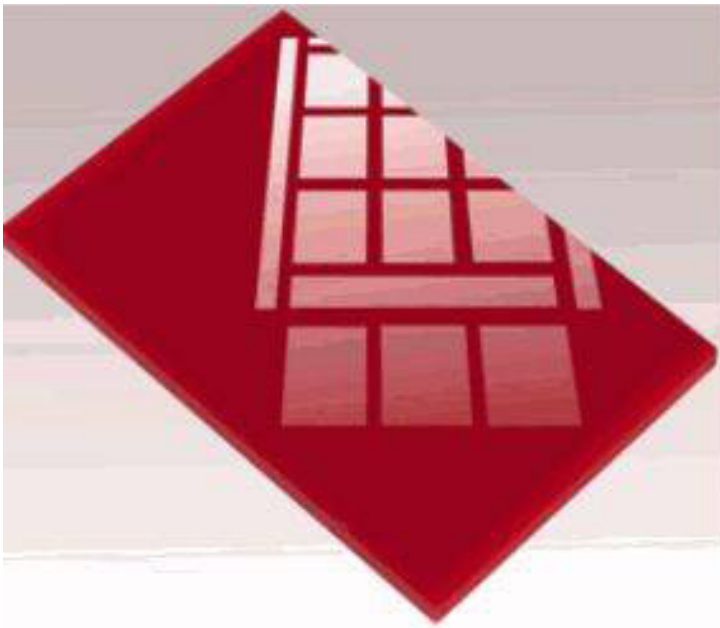

# Haze

Haze is produced by imperfections/irregularities on the surface that affect the light distribution around the specular angle.

## Specular angle

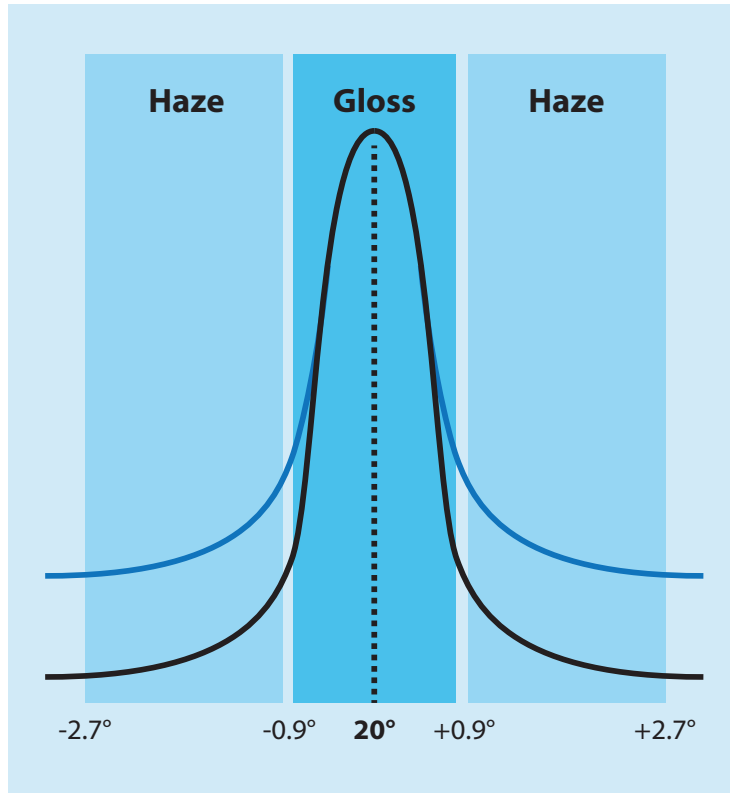

Haze is sometimes compared to “turbidity”

## Without Haze



## With Haze



DOI measures the **Distinctness Of Image:** how clearly an image appears on a reflective surface.

A low DOI indicates image distortion (perfect mirror has a DOI of 100)

DOI quantifies the “sharpness of the image

A low DOI can be seen as the result of a high haze

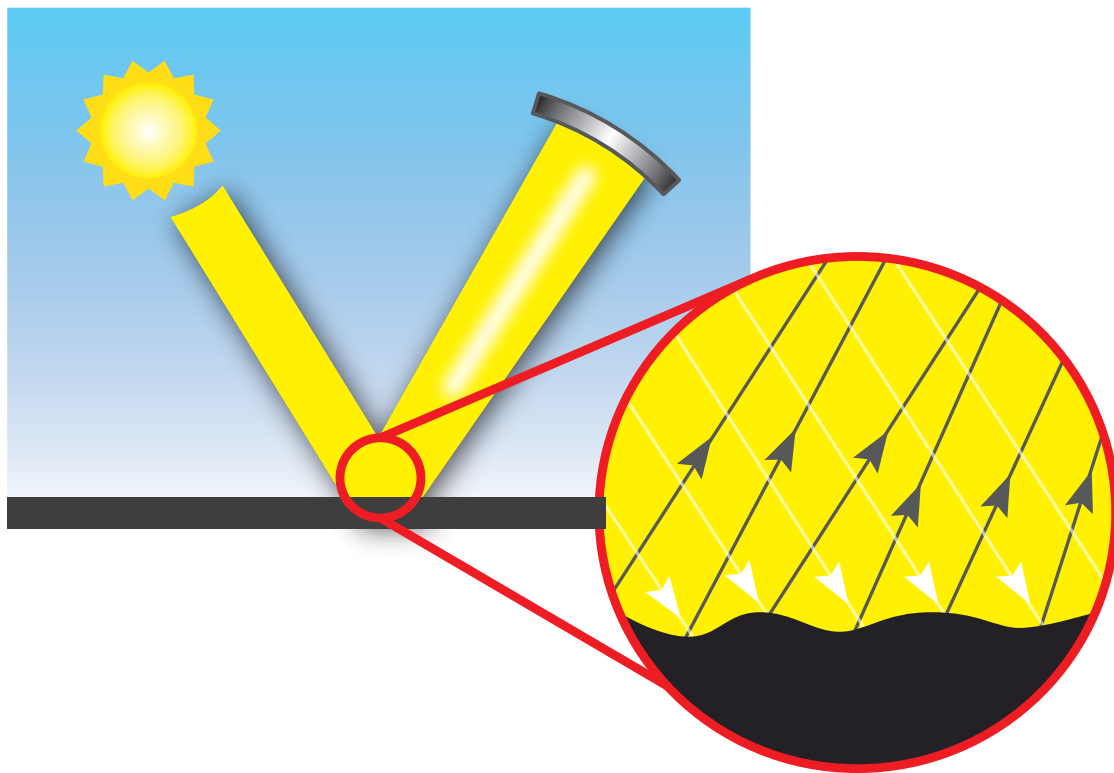

Haze increases / DOI decreases

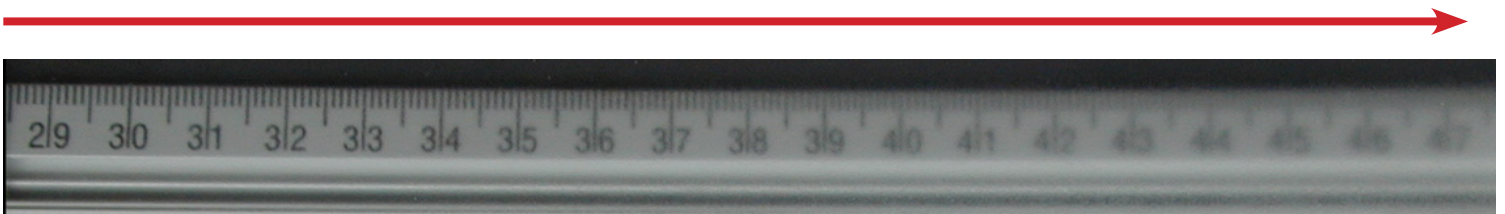

RIQ  
**Reflected Image Quality**  
is an improved version of the  
DOI

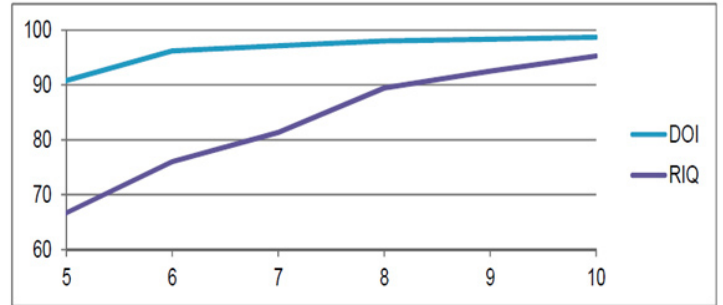

*Samples 5 to 10 above show similar DOI results but RIQ measurements provide discriminant data.*

RIQ provides a better response to orange peel effects on a wider range of materials and textures.

For low gloss surfaces or on samples with low orange peel, RIQ provides results even more in accordance with our visual perception (compared to DOI)

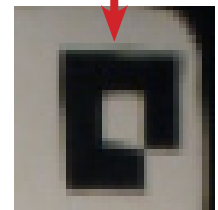
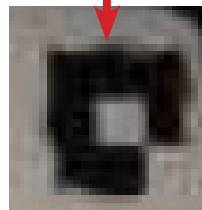
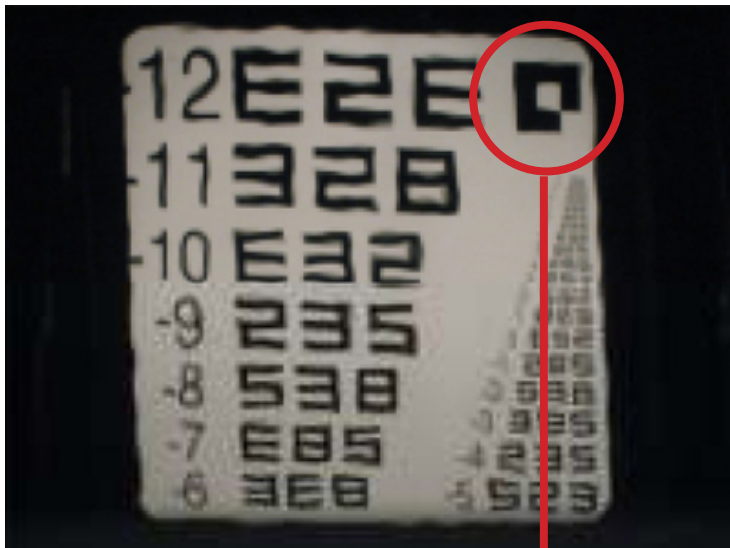



RSpec is the  
**Peak Specular Reflectance**  
at  $\pm 0.0991^\circ$  around the specular angle.

This very precise measurement quantifies the surface texture as any wave or ripple on the surface will create light diffraction and therefore affect the “light response”.

Perfectly smooth surface:  
RSpec value = gloss value

Uneven/textured surface:  
RSpec value drops  
RSpec value < Gloss value

Same paint applied on 2 different surfaces

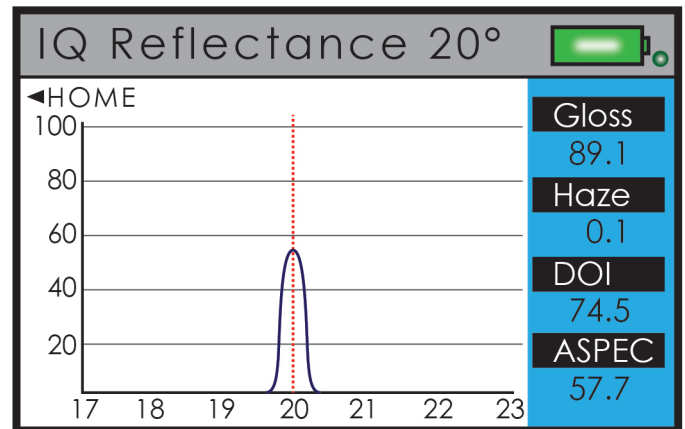
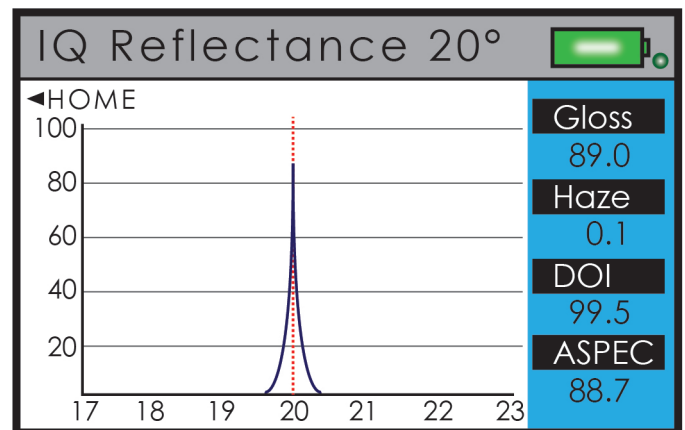

Which one would you choose?

# Case Study

4 “similar samples”

4 similar samples were evaluated against each other  
Identifications: Plate 1 / Plate 2 / Plate 3 / Plate 4

Gloss measurements on 24 specimens  
of each samples

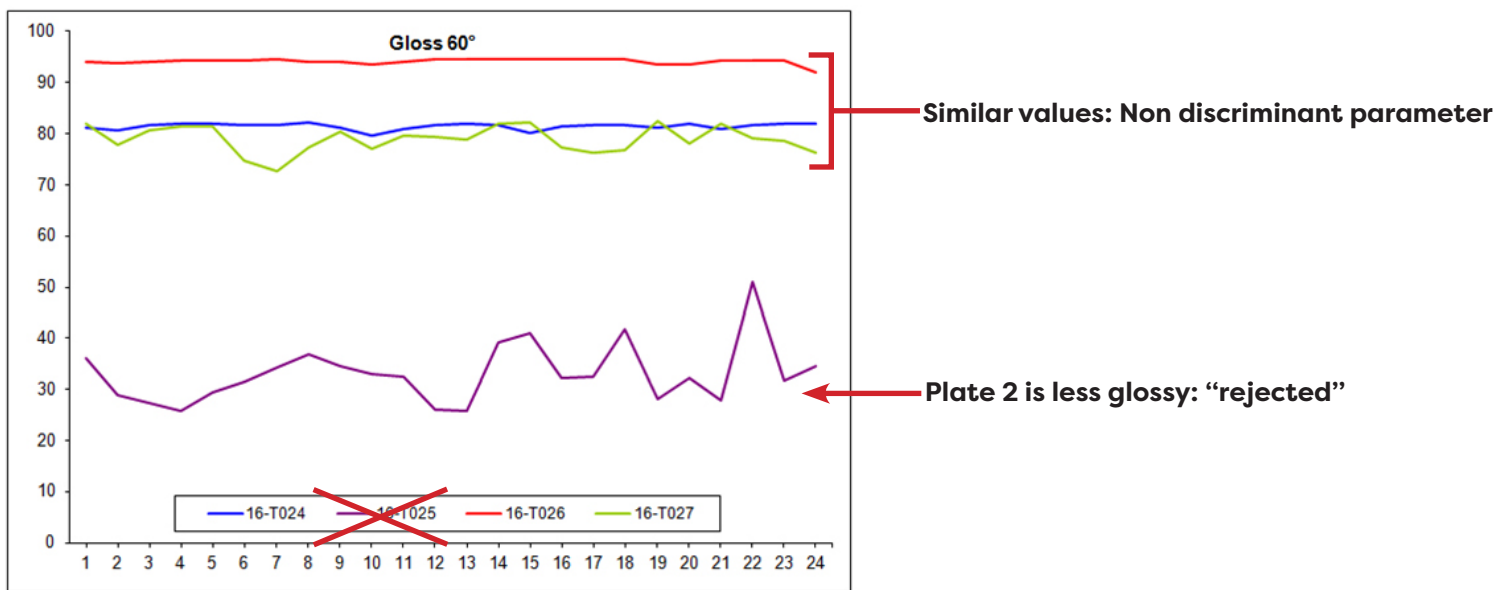

	L	a	b
Plate 1	49.20	-4.39	-41.57
Plate 2	49.29	-4.12	-41.23
Plate 3	48.71	-4.49	-43.39
Plate 4	48.66	-6.01	-42.34

Initial color measurements (similar)

# Case Study

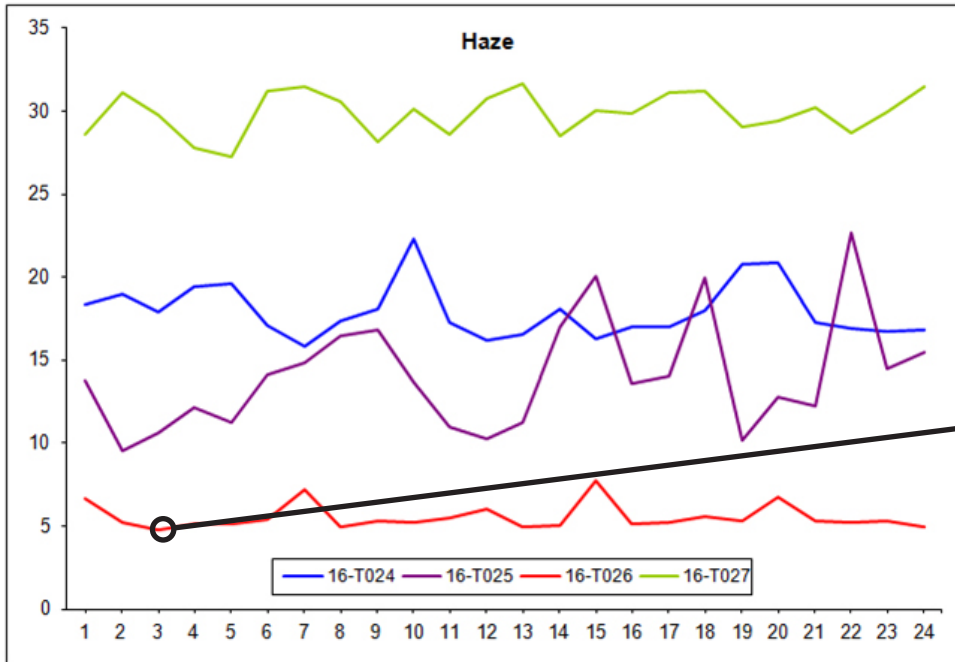

**Haze** measurements  
on 24 specimens of each samples

Ideal value: 0

**Best contrast**

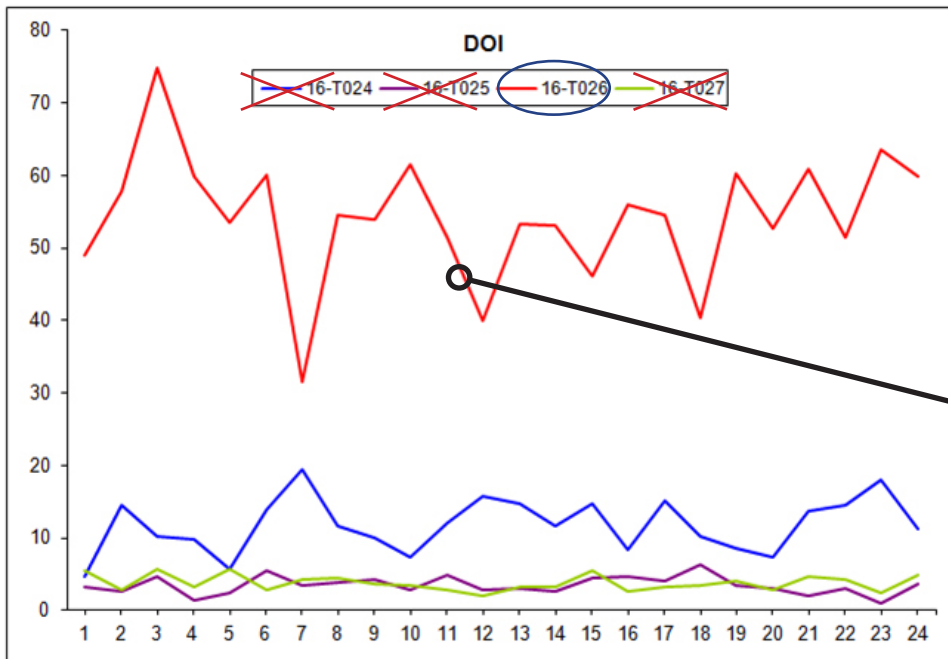

**DOI** measurements  
on 24 specimens of each samples

Ideal value: 100

**Best reflection**

# Case Study

## Samples performance:

	Gloss	Haze	DOI	Sum
Plate 1	+	+	--	0
Plate 2	-	-	--	-4
Plate 3	+	++	++	+5
Plate 4	+	--	--	-3

++ : Excellent performance / results → -- : Poor performance / results



# Case Study

	Gloss	Haze	DOI	Sum
Plate 1	+	+	--	0
Plate 2	-	⊖	⊖	-4
Plate 3	+	⊕	⊕	+5
Plate 4	+	--	--	-3

